

UK STOCK SMART TIDE



The Smart Tide is the perfect travel companion for your next trip! The double walled vacuum insulated travel bottle will keep water cold for up to 24 hours and hot drinks hot for up to 18 hours. Combining the convenience of a plastic bottle with the high efficiency and eco-friendly benefits of a traditional vacuum bottle. The Tide bottle is also suitable for juice drinks! The Tide bottle is a versatile drinking bottle with a generous 500ml capacity that will keep you hydrated on the go!

*Please note: These product images are used for illustration purposes only and the colours of the final product may vary slightly.

Features

- ✔ Designed with an airtight and leak-proof lid to prevent any spills
- ✔ Suitable for your favourite drinks, from Coffee to ice cold water
- ✔ Ideal for offices, schools, travelling and outdoor activities
- ✔ Premium Stainless Steel
- ✔ Lead Time: 5-7 Working Days
- ✔ MOQ: 50 units

Colour Options

- Silver
- Matte Black
- Matte White
- Matte Blue (PMS 287 C)
- Matte Yellow (PMS 113 C)
- Matte Green (PMS 2299 C)



Printing Area and Branding Options

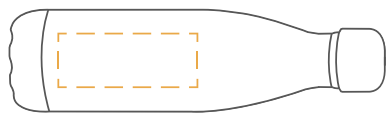

 **Engraved Print:**
100 x 45mm

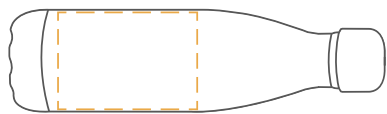

 **1-2 Spot Colour Print:**
100 x 70mm

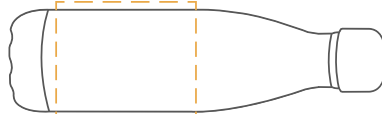

 **Full Colour Half Wrap Print:**
100 x 85mm

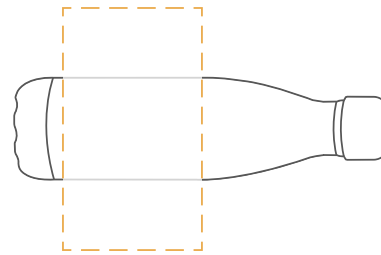

 **1 Spot Colour Wrap Print:**
170 x 100mm

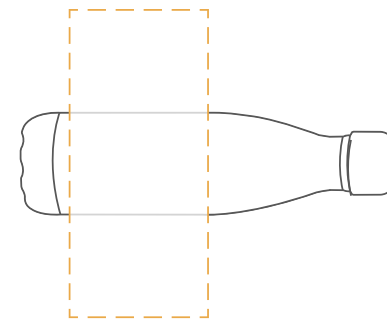

 **Full Colour Wrap Print:**
222 x 100mm

Print Options

1 Spot Colour 100 x 70mm



Standard UV Full Colour 100 x 30mm



Full Colour Half Wrap 100 x 85mm

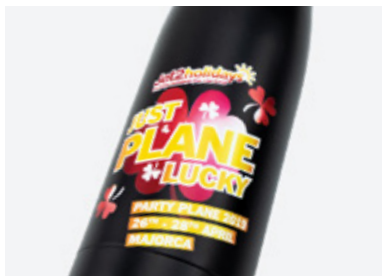

1 Spot Colour Wrap 180 x 100mm



Full Colour Wrap 222 x 100mm



Technical Specification

24 Hours cold

18 Hours hot

Material: 304 Stainless Steel

Airtight sealed lid

Product Size and Weight

Length: 270mm

Width: 67mm

Height: 67mm

Product Weight: 360g



Please ensure lid is firmly secured

Temperature inside bottle may vary depending on the initial temperature of bottle, and how many times the bottle lid is opened and closed.

***Hand wash only**

Carton Specification

Size: 76 x 39 x 27cm

Quantity: 50 Unit

Weight: 18kg